

Applicable Model

E16

Drawing Title

Intercom Panel

Drawing Unit

mm

Drawing Scale

Not to scale

**DRAFT
SUBJECT TO
CHANGE**

Last Revised

Mar 06,2023

Drawing Version

V1.0

Page

1 of 8

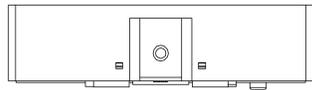

6 **BOTTOM VIEW**



2 **RIGHT VIEW**

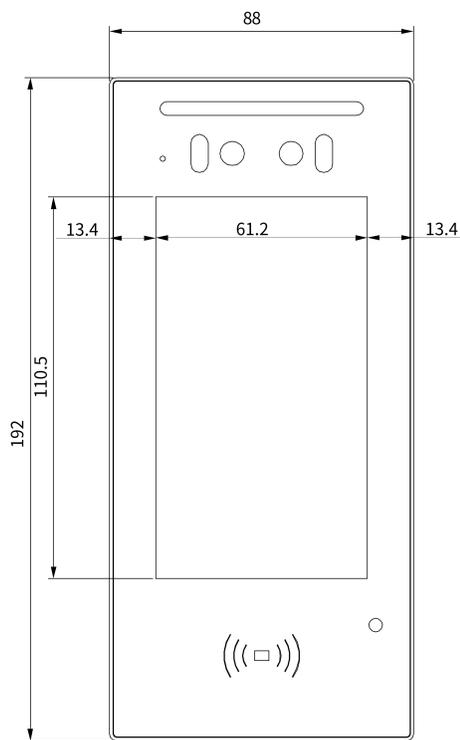

1 **FRONT VIEW**



3 **LEFT VIEW**



5 **TOP VIEW**

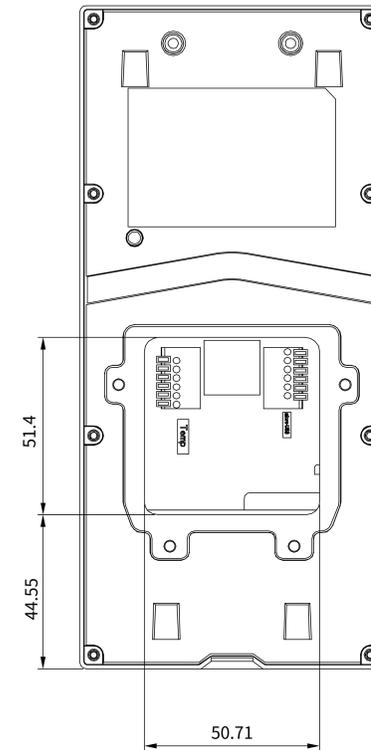

4 **BACK VIEW**

Applicable Model

E16

Drawing Title

Wall Mounting Bracket

Drawing Unit

mm

Drawing Scale

Not to scale

**DRAFT
SUBJECT TO
CHANGE**

Last Revised

Mar 06,2023

Drawing Version

V1.0

Page

2 of 8

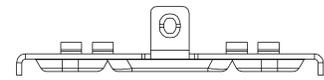

⑥ **BOTTOM VIEW**



② **RIGHT VIEW**

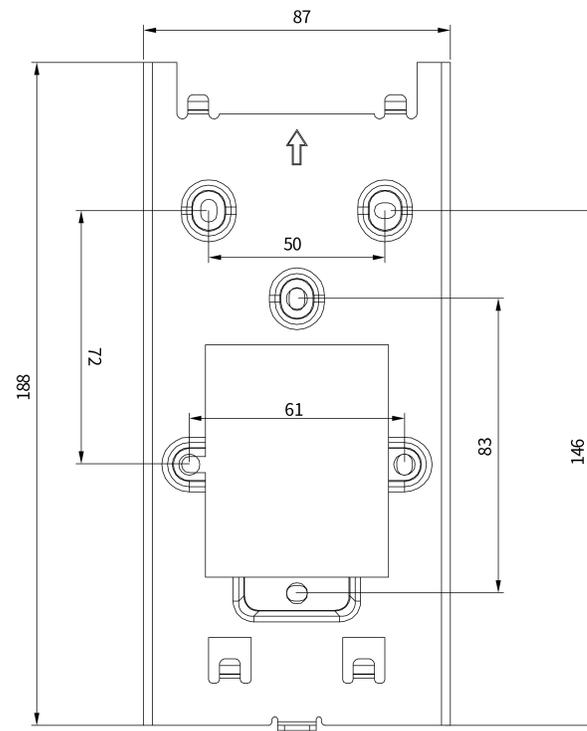

① **FRONT VIEW**

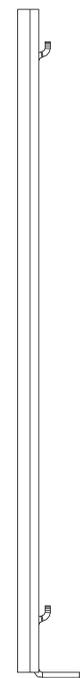

③ **LEFT VIEW**

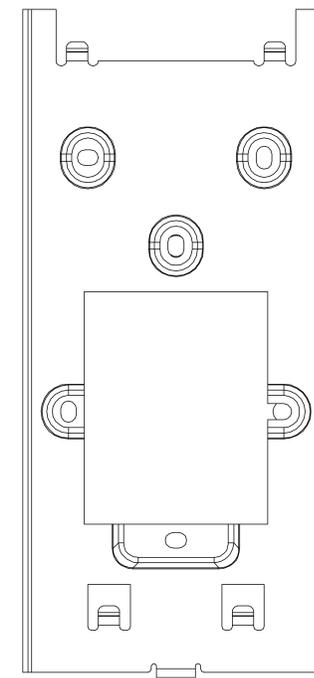

④ **BACK VIEW**

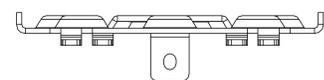

⑤ **TOP VIEW**

Applicable Model

E16

Drawing Title

Placement

Drawing Unit

mm

Drawing Scale

Not to scale

**DRAFT
SUBJECT TO
CHANGE**

Last Revised

Mar 06,2023

Drawing Version

V1.0

Page

3 of 8

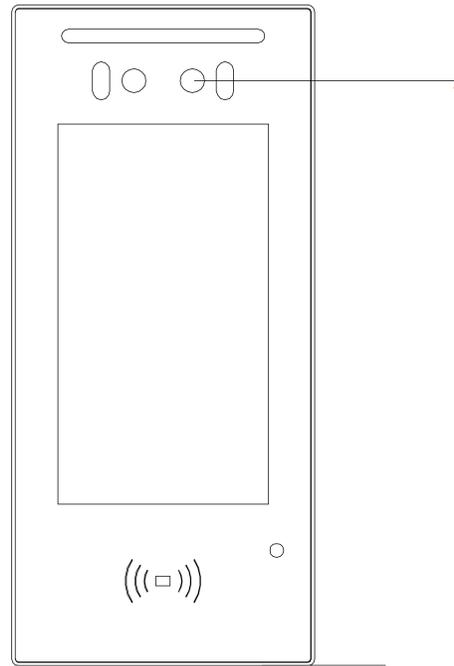

① INTERCOM PANEL FRONT VIEW

1240mm TO BOTTOM OF PANEL

1400mm TO CENTER OF CAMERA

ADA Compliance Requirement

GROUND

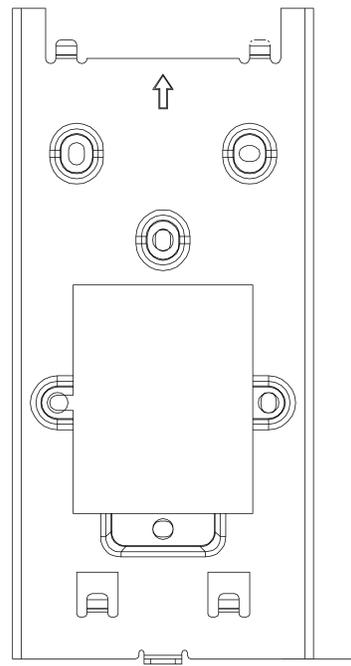

② FRONT VIEW:WALL MOUNTING BRACKET PLACEMENT

1240mm TO BOTTOM OF BRACKET

GROUND

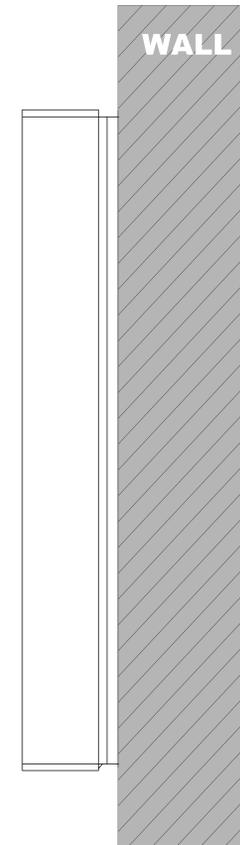

③ SIDE VIEW:INTERCOM ON WALL

Applicable Model

E16

Drawing Title

Wall Mounting Bracket
With Temperature
Measurement Module

Drawing Unit

mm

Drawing Scale

Not to scale

**DRAFT
SUBJECT TO
CHANGE**

Last Revised

Mar 06, 2023

Drawing Version

V1.0

Page

4 of 8

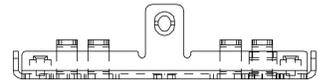

⑥ **BOTTOM VIEW**

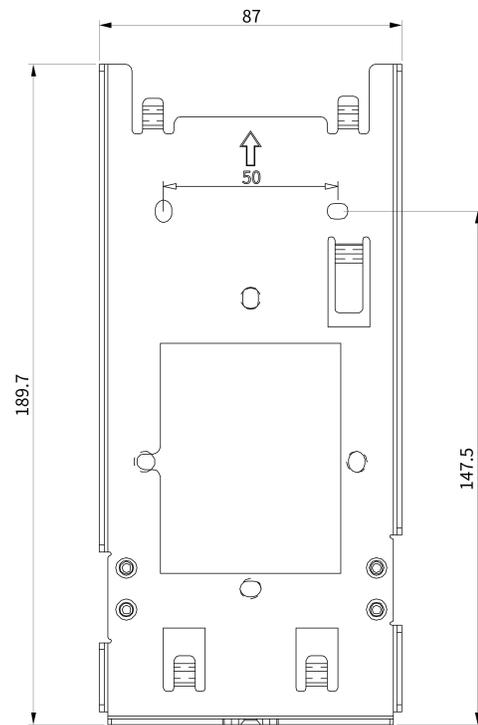

① **FRONT VIEW**



② **RIGHT VIEW**



③ **LEFT VIEW**

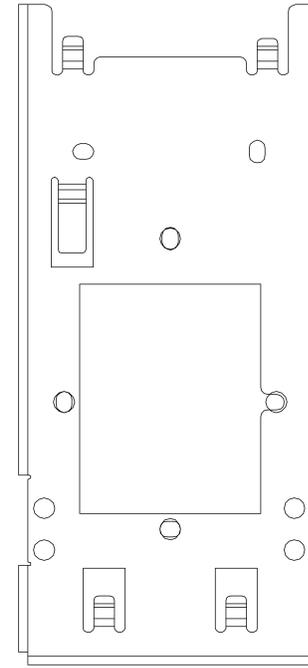

④ **BACK VIEW**

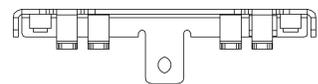

⑤ **TOP VIEW**

Applicable Model

E16

Drawing Title

Placement

Drawing Unit

mm

Drawing Scale

Not to scale

**DRAFT
SUBJECT TO
CHANGE**

Last Revised

Mar 06, 2023

Drawing Version

V1.0

Page

5 of 8

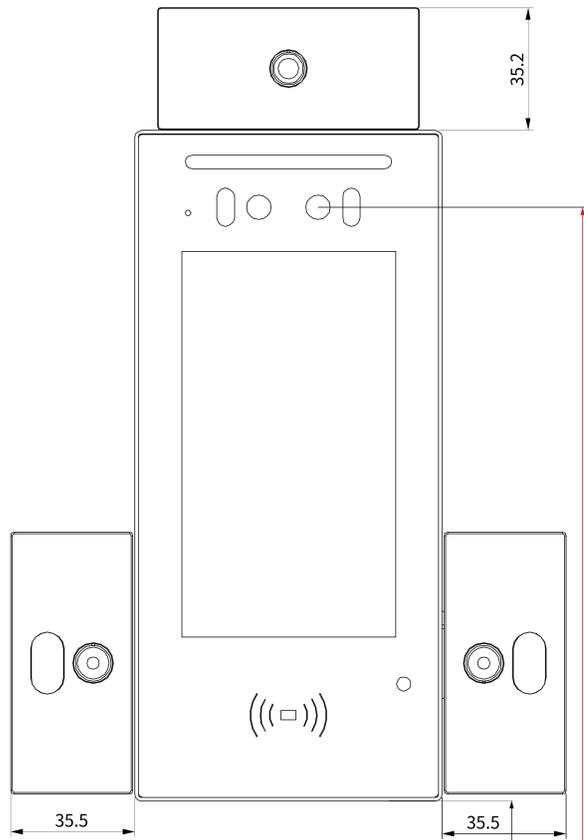

① INTERCOM PANEL WITH TEMPERATURE MEASUREMENT MODULE FRONT VIEW

1240mm TO BOTTOM OF PANEL

1400mm TO CENTER OF CAMERA

ADA Compliance Requirement

GROUND

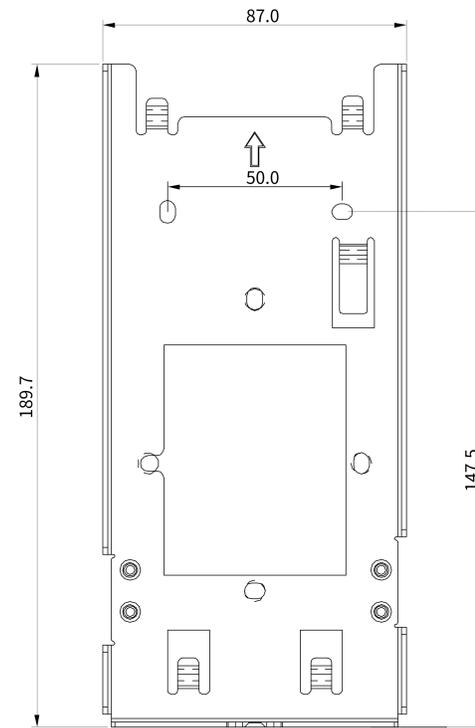

② FRONT VIEW:WALL MOUNTING BRACKET PLACEMENT

1240mm TO BOTTOM OF BRACKET

GROUND

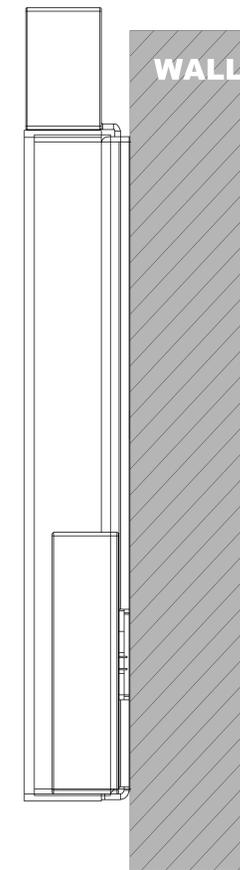

③ SIDE VIEW:INTERCOM ON WALL

Applicable Model

E16

Drawing Title

In-Wall Mounting
Decorative Panel

Drawing Unit

mm

Drawing Scale

Not to scale

**DRAFT
SUBJECT TO
CHANGE**

Last Revised

Mar 06,2023

Drawing Version

V1.0

Page

6 of 8



⑥ **BOTTOM VIEW**



② **RIGHT VIEW**

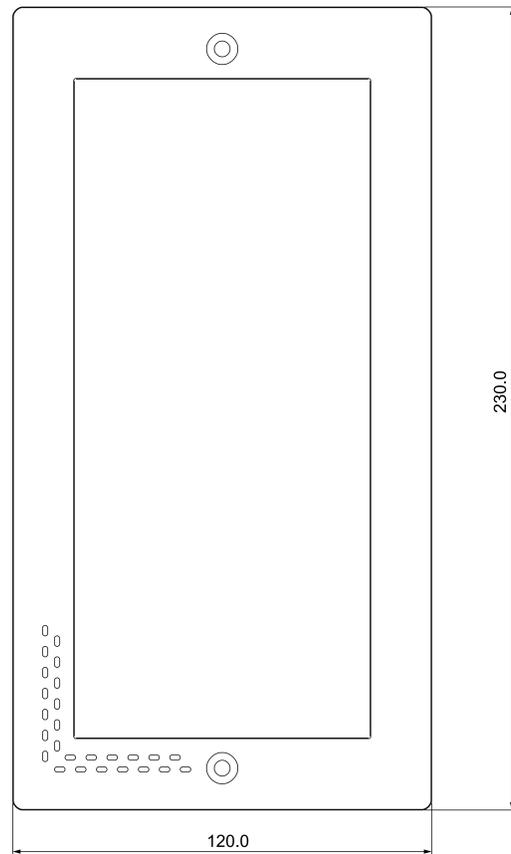

① **FRONT VIEW**

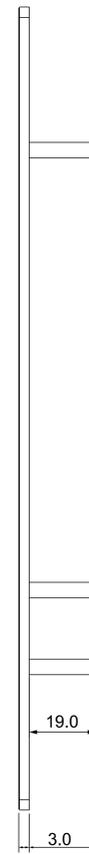

③ **LEFT VIEW**

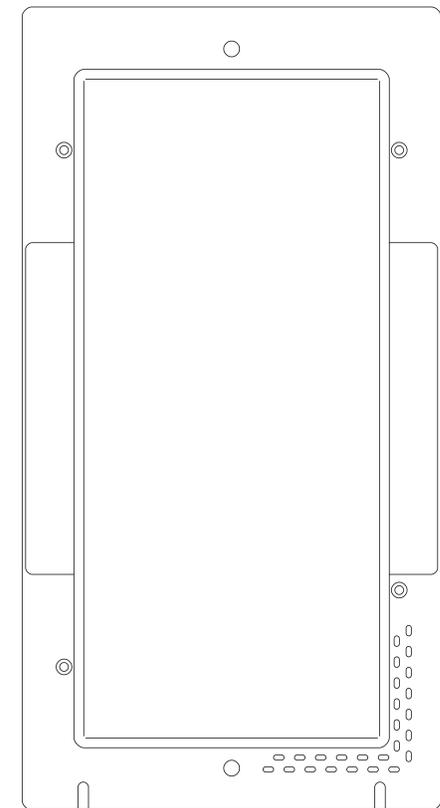

④ **BACK VIEW**



⑤ **TOP VIEW**

Applicable Model

E16

Drawing Title

Flushing Mounting Box

Drawing Unit

mm

Drawing Scale

Not to scale

**DRAFT
SUBJECT TO
CHANGE**

Last Revised

Mar 06,2023

Drawing Version

V1.0

Page

7 of 8

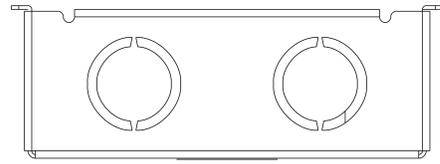

⑥ **BOTTOM VIEW**

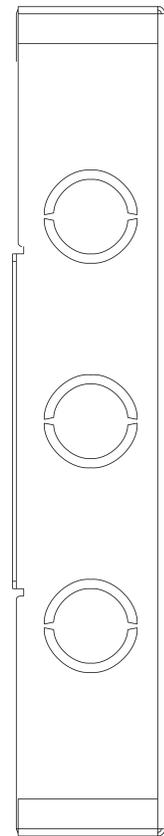

② **RIGHT VIEW**

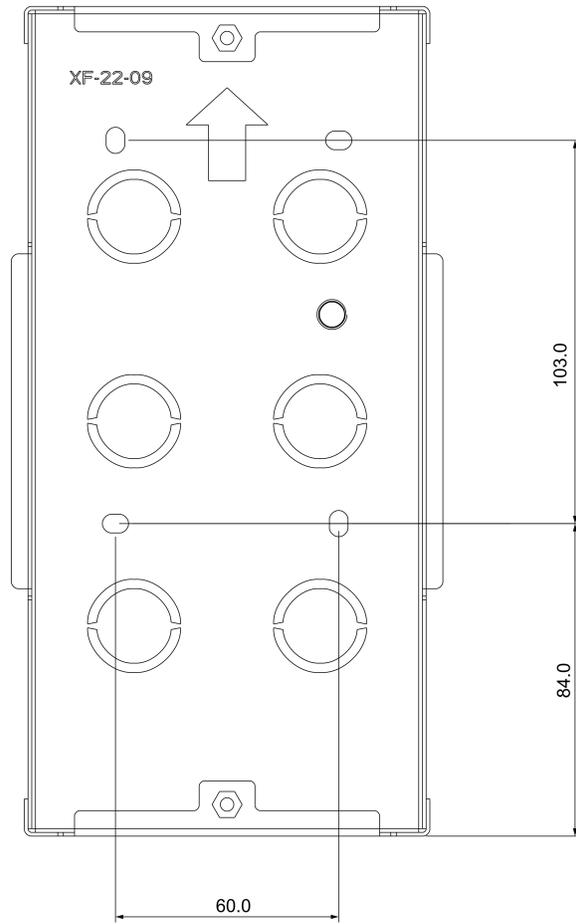

① **FRONT VIEW**

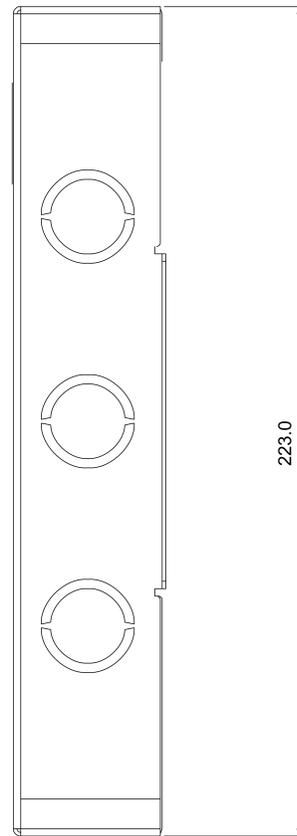

③ **LEFT VIEW**

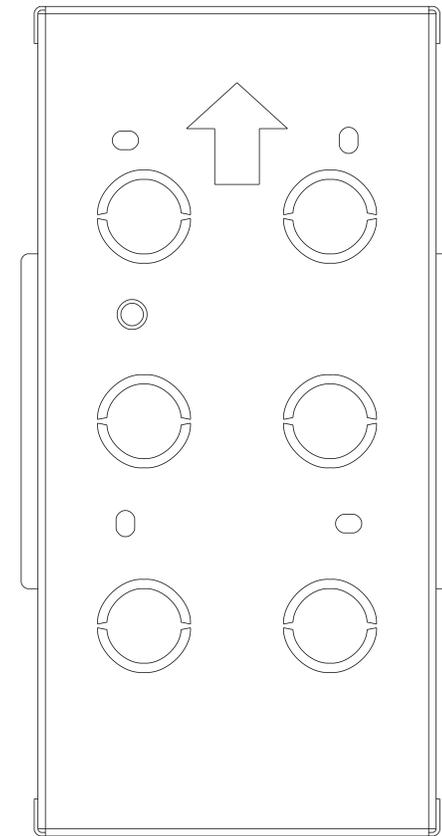

④ **BACK VIEW**

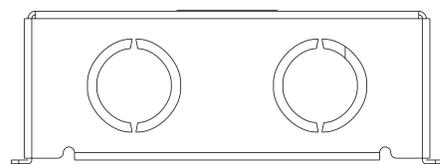

⑤ **TOP VIEW**

Applicable Model

E16

Drawing Title

Placement

Drawing Unit

mm

Drawing Scale

Not to scale

**DRAFT
SUBJECT TO
CHANGE**

Last Revised

Mar 06,2023

Drawing Version

V1.0

Page

8 of 8

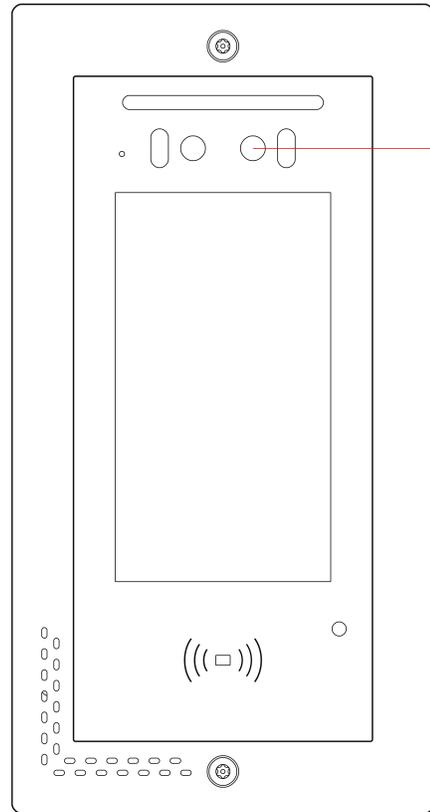

① INTERCOM PANEL FRONT VIEW

1211mm TO BOTTOM OF PANEL

1400mm TO CENTER OF CAMERA

ADA Compliance Requirement

GROUND

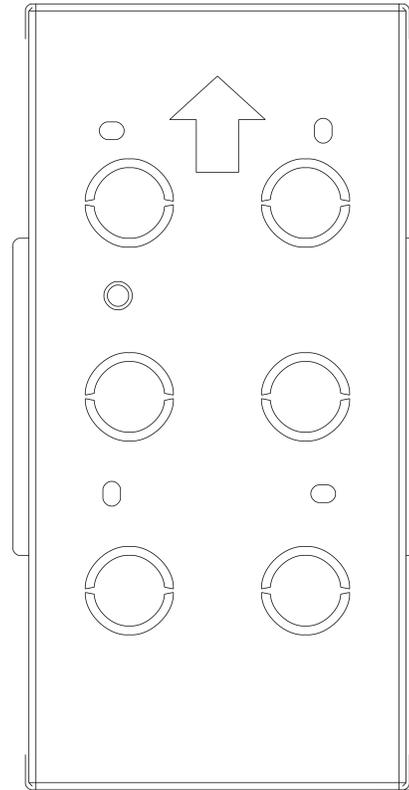

② FRONT VIEW:FLUSHING MOUNTING BOX PLACEMENT

1214.5mm TO BOTTOM OF BRACKET

GROUND

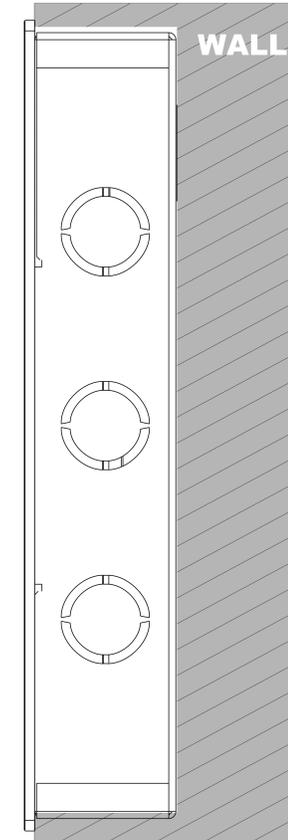

③ SIDE VIEW:INTERCOM IN WALL