

6 **BOTTOM VIEW**

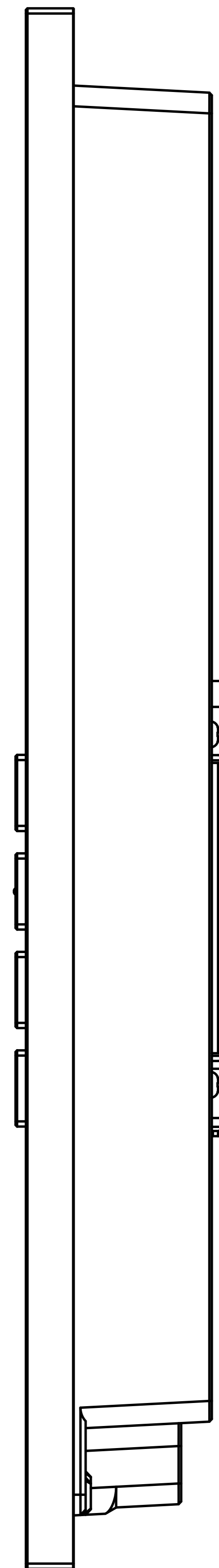

2 **RIGHT VIEW**

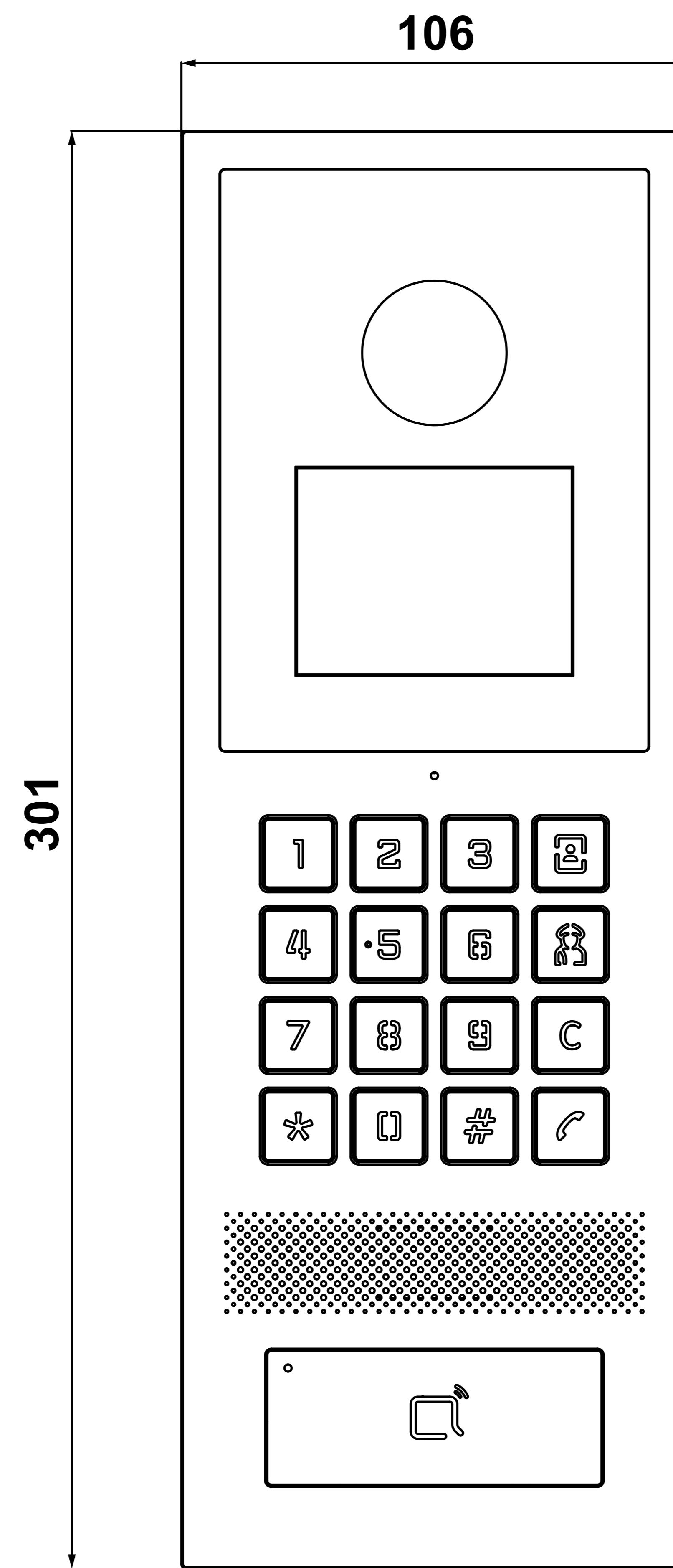

1 **FRONT VIEW**

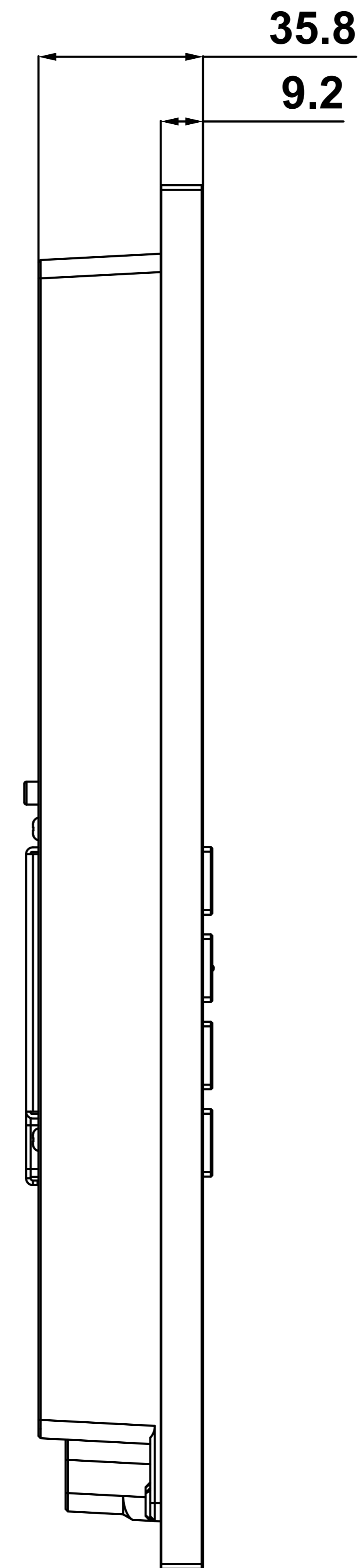

3 **LEFT VIEW**

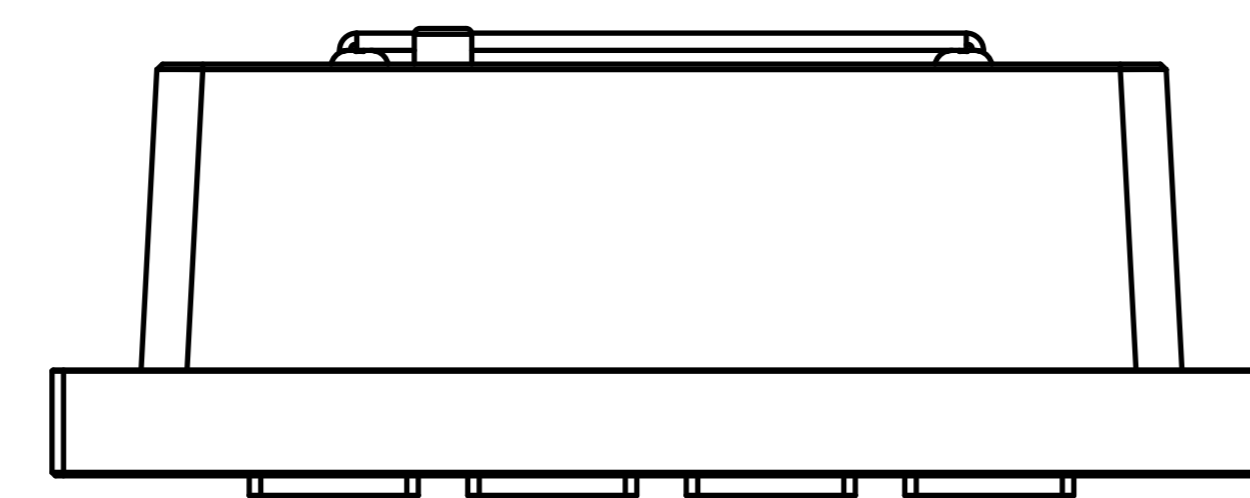

5 **TOP VIEW**

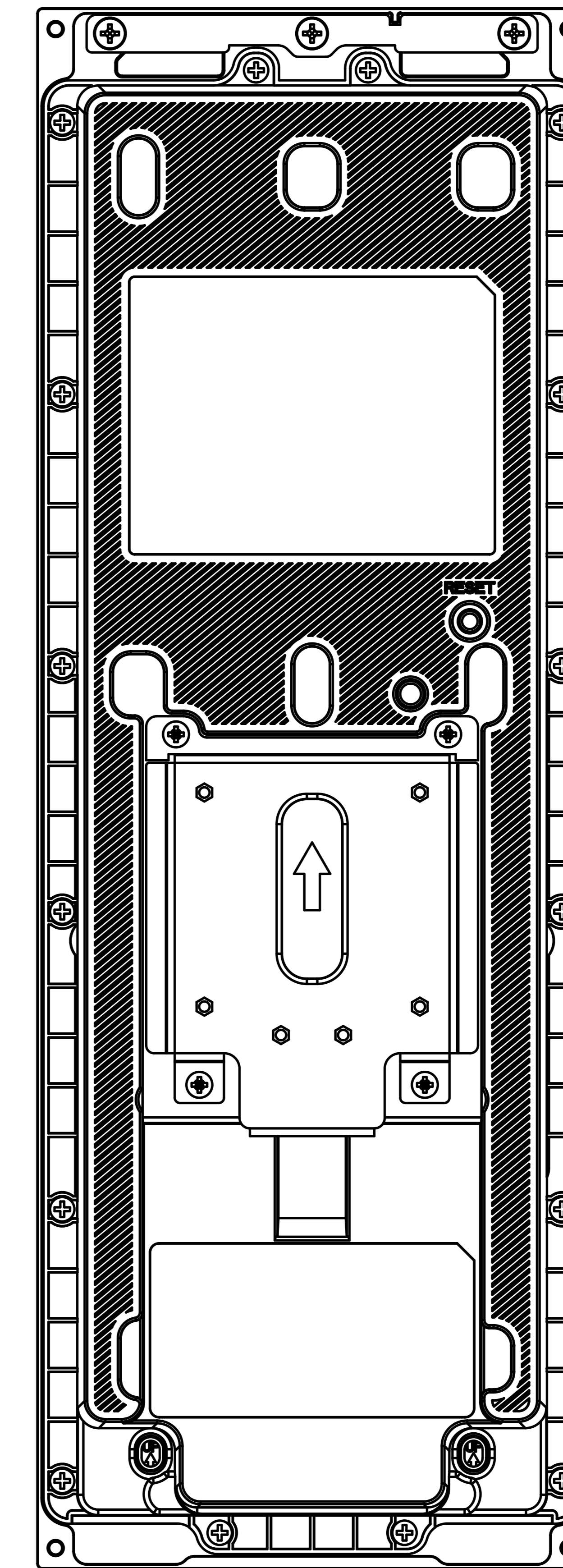

4 **BACK VIEW**

Applicable Model

S532

Drawing Title

Wall Mounting Box

Drawing Unit

mm

Drawing Scale

Not to scale

**DRAFT
SUBJECT TO
CHANGE**

Last Revised

Oct 12, 2023

Drawing Version

V1.0

Page

2 of 6

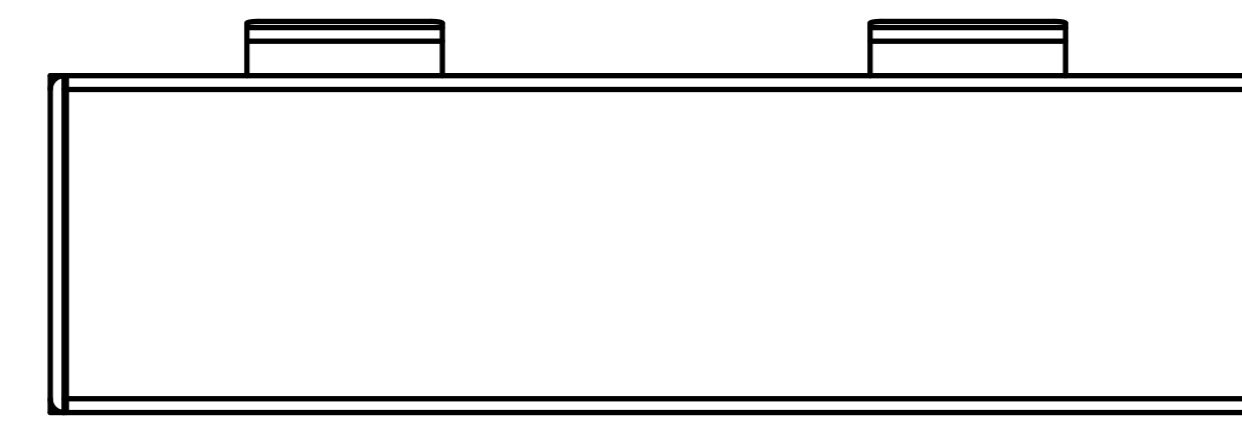

⑥ **BOTTOM VIEW**

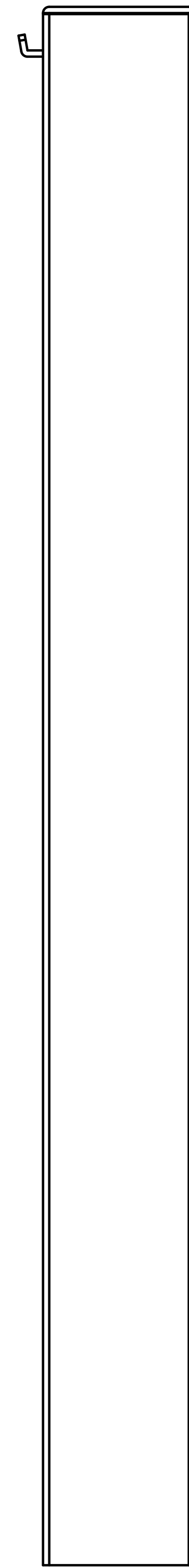

② **RIGHT VIEW**

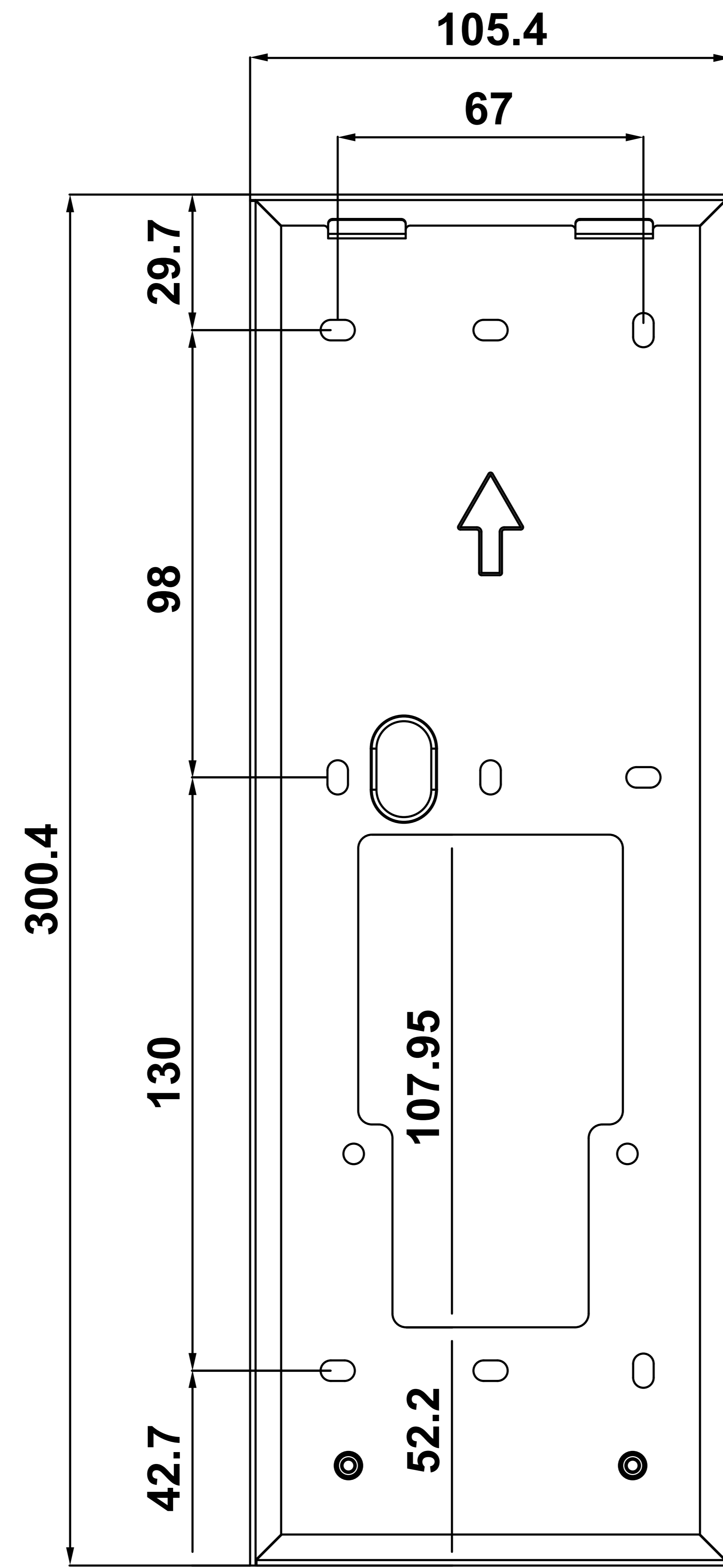

① **FRONT VIEW**

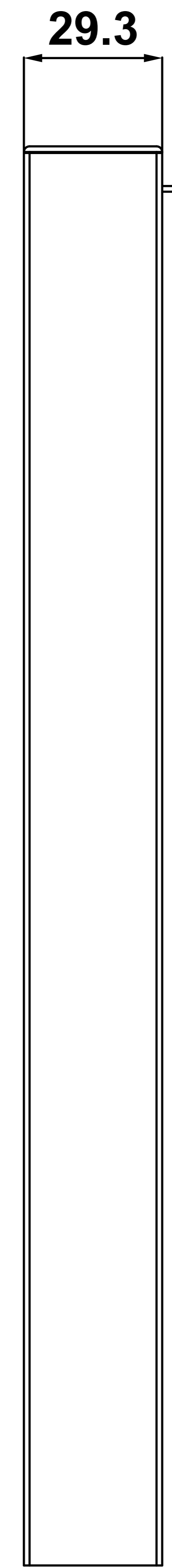

③ **LEFT VIEW**

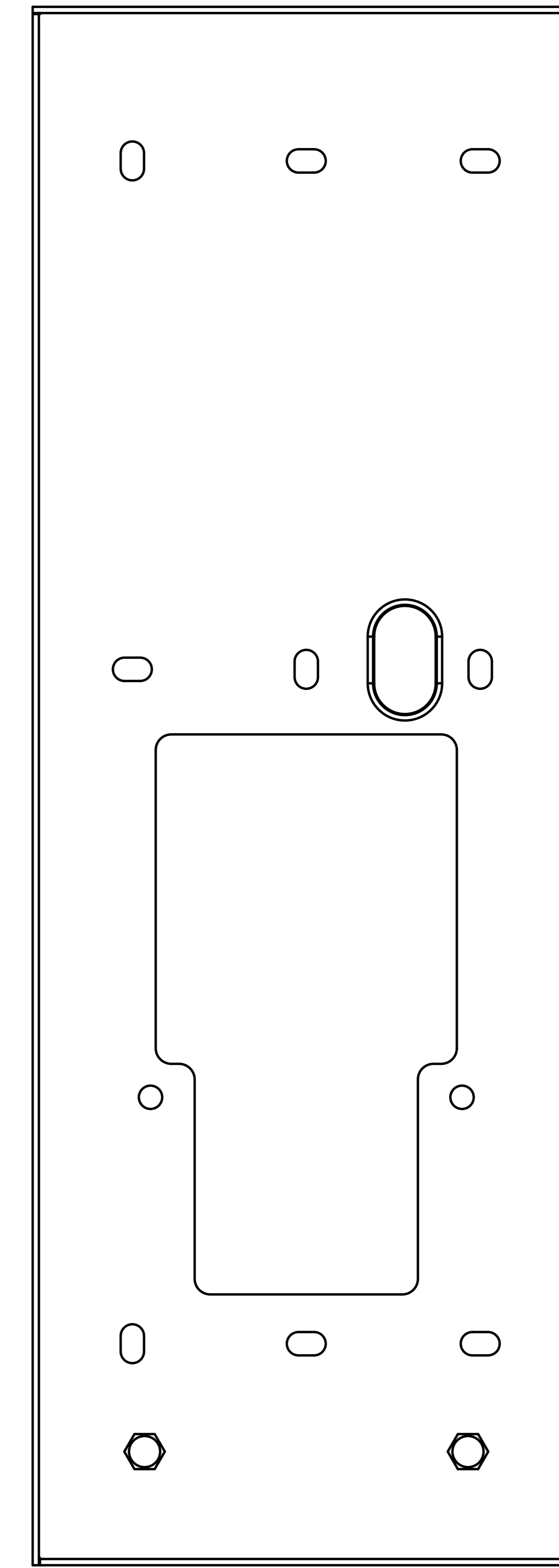

④ **BACK VIEW**

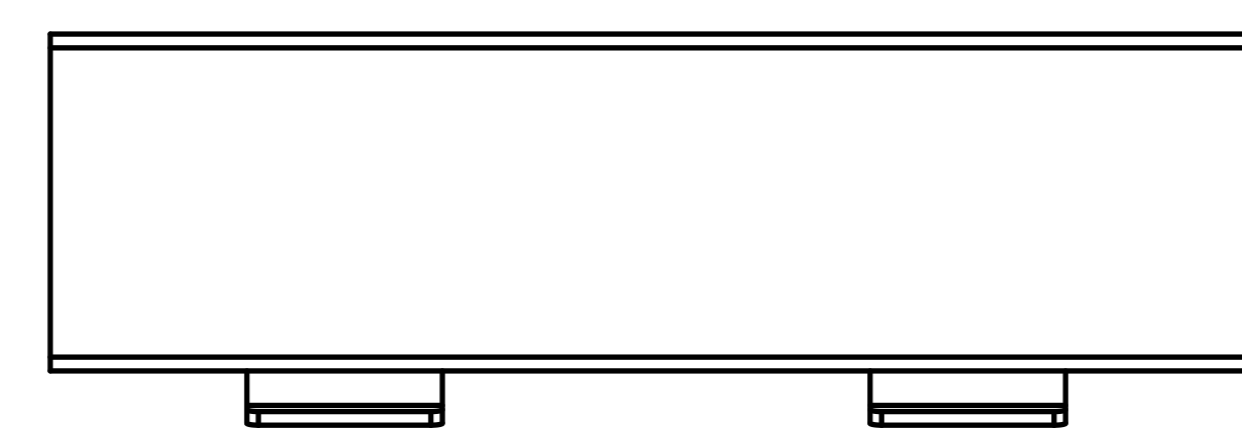

⑤ **TOP VIEW**

Applicable Model

S532

Drawing Title

Placement

Drawing Unit

mm

Drawing Scale

Not to scale

**DRAFT
SUBJECT TO
CHANGE**

Last Revised

Oct 12, 2023

Drawing Version

V1.0

Page

3 of 6

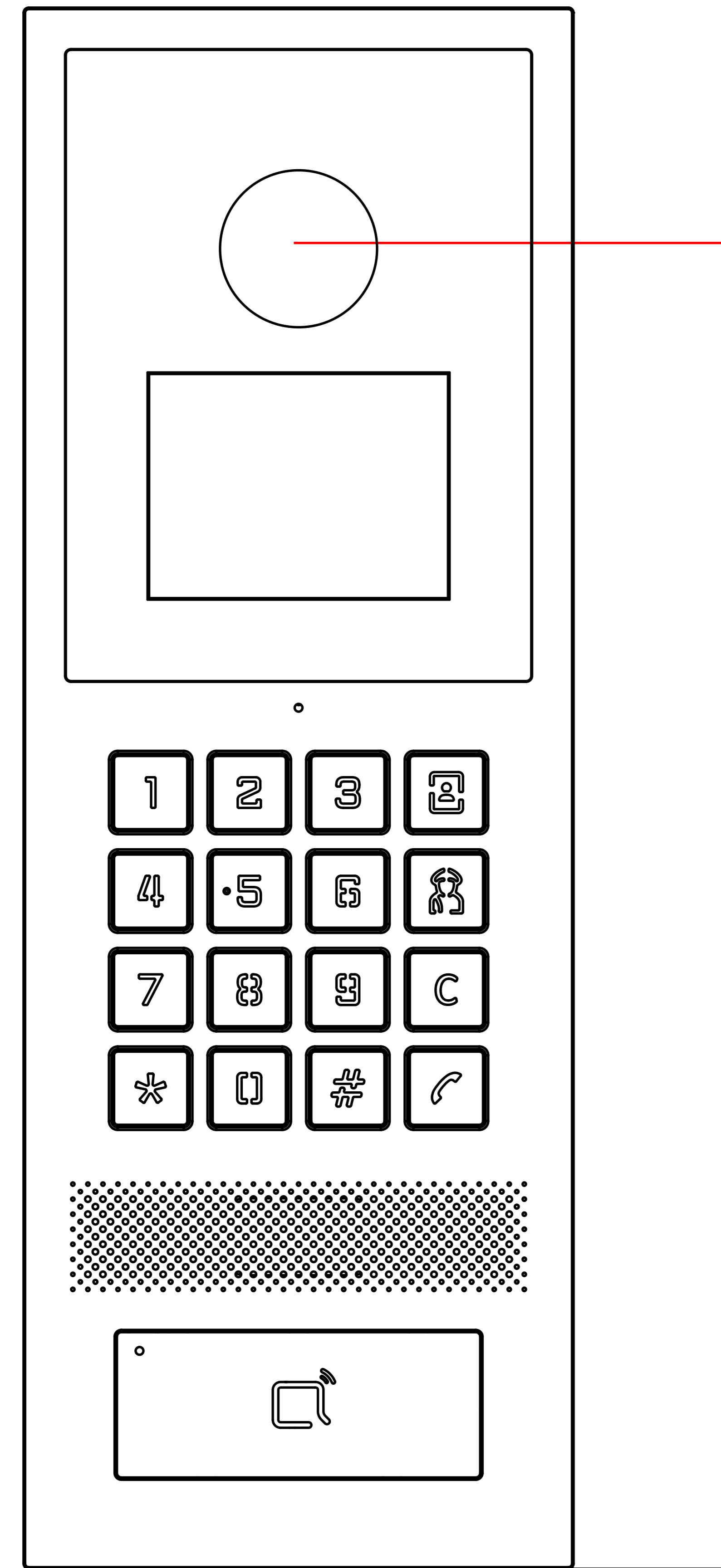

① INTERCOM PANEL FRONT VIEW

1145.5mm TO BOTTOM OF PANEL

1400mm TO CENTER OF CAMERA

ADA Compliance Requirement

GROUND

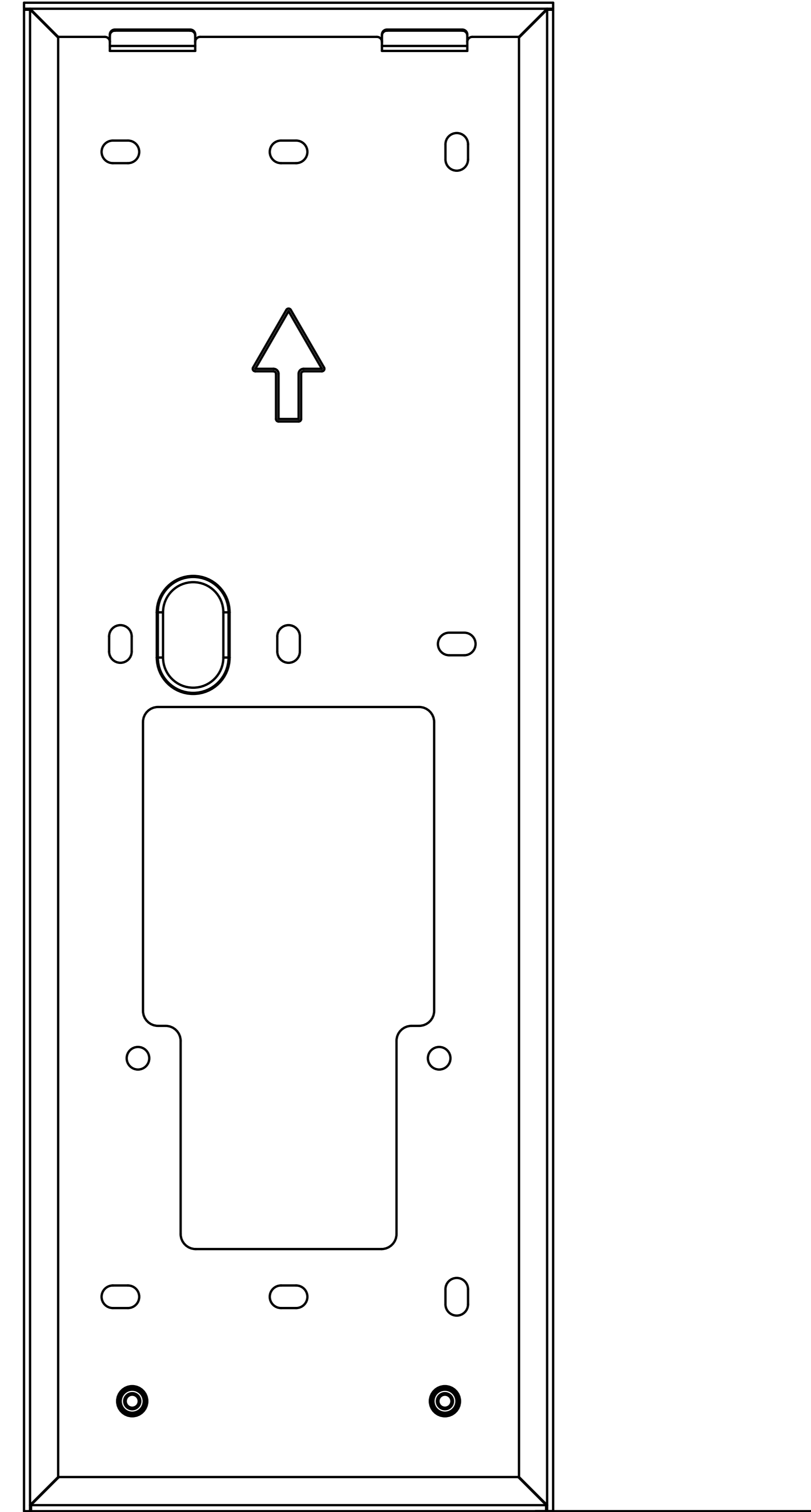

② FRONT VIEW:WALL MOUNTING BRACKET PLACEMENT

1145.8mm TO BOTTOM OF BRACKET

GROUND

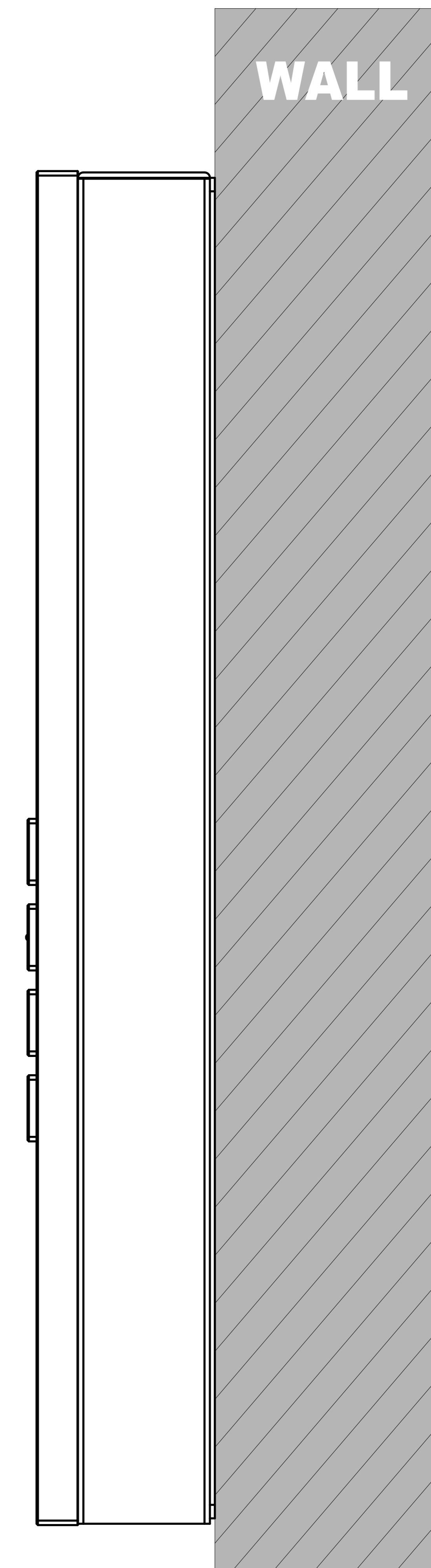

③ SIDE VIEW:INTERCOM ON WALL

Applicable Model

S532

Drawing Title

Flush Mounting Bracket

Drawing Unit

mm

Drawing Scale

Not to scale

**DRAFT
SUBJECT TO
CHANGE**

Last Revised

Oct 12, 2023

Drawing Version

V1.0

Page

4 of 6

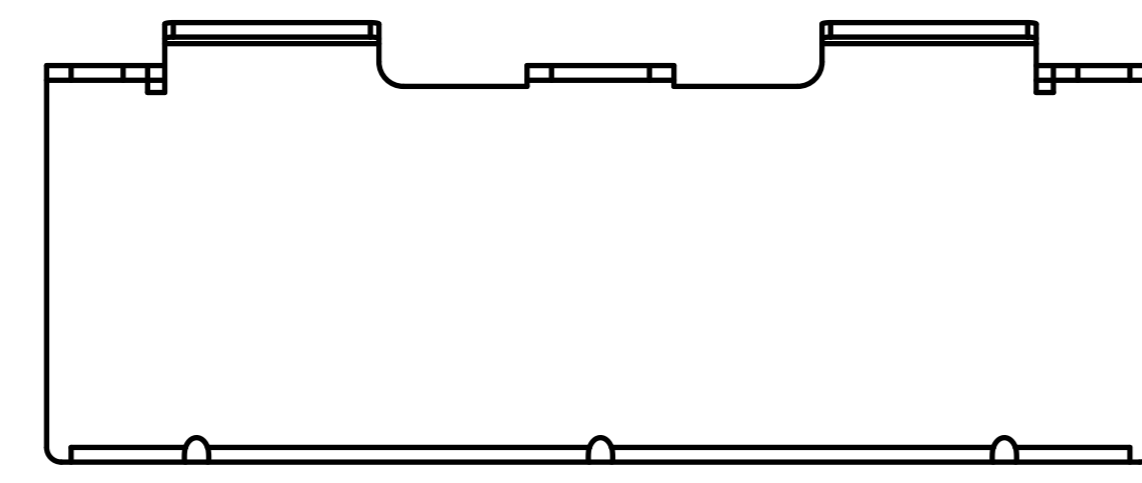

⑥ **BOTTOM VIEW**



② **RIGHT VIEW**

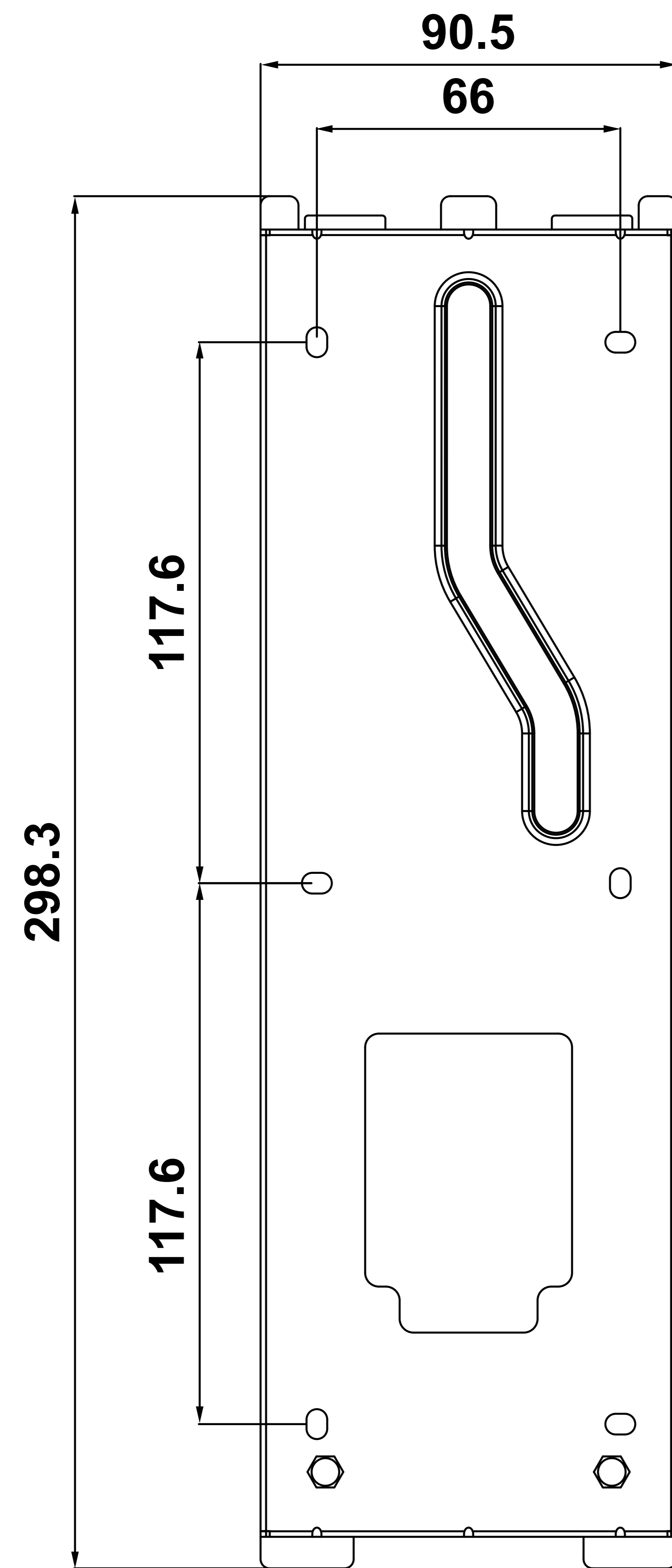

① **FRONT VIEW**

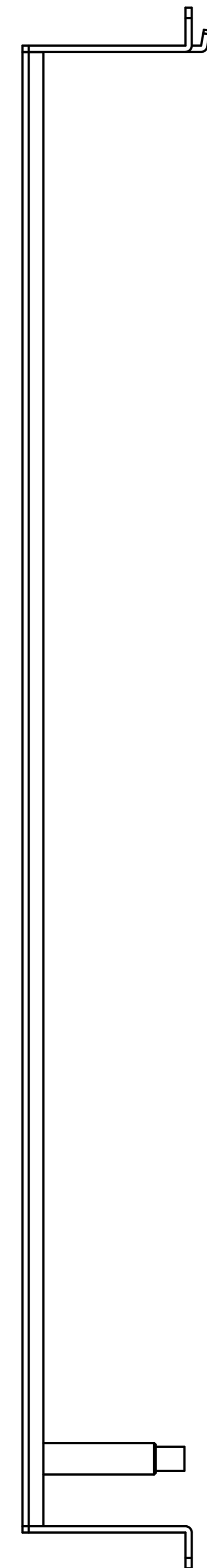

③ **LEFT VIEW**

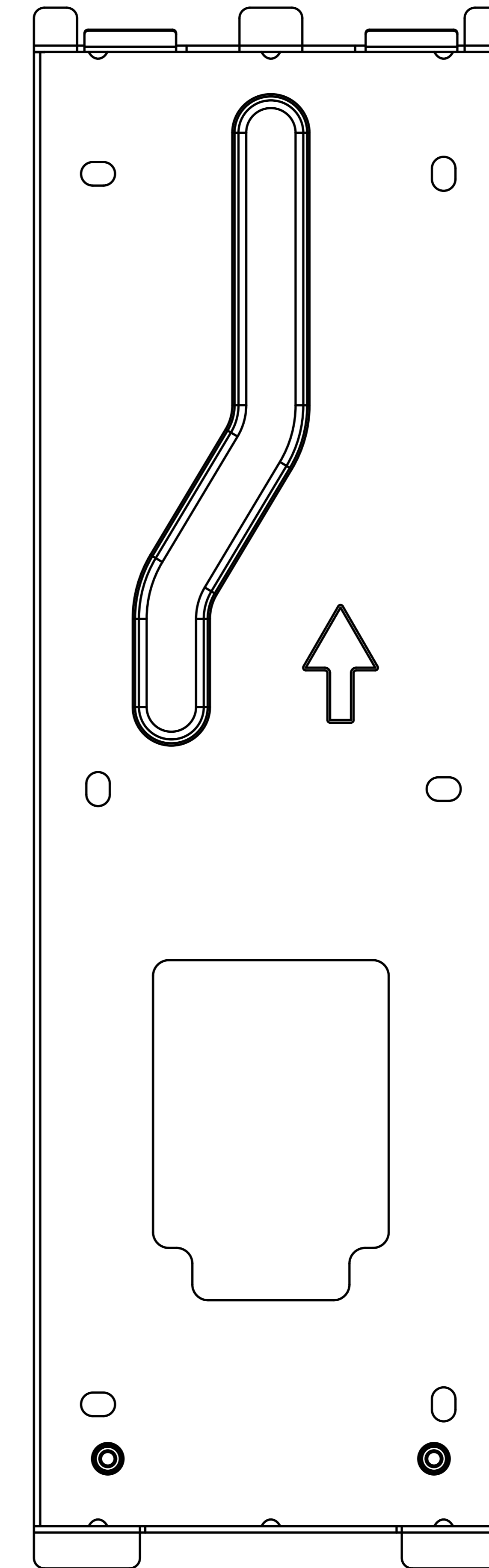

④ **BACK VIEW**

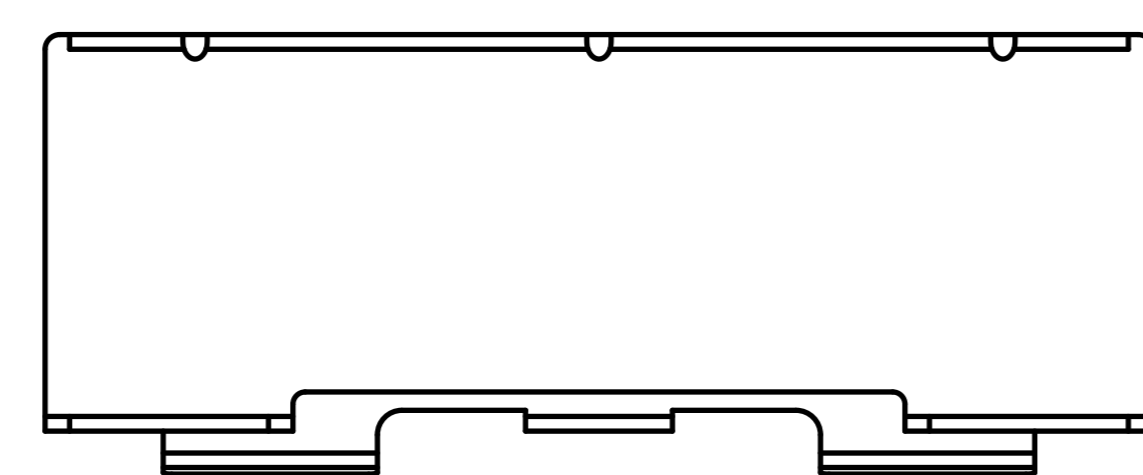

⑤ **TOP VIEW**

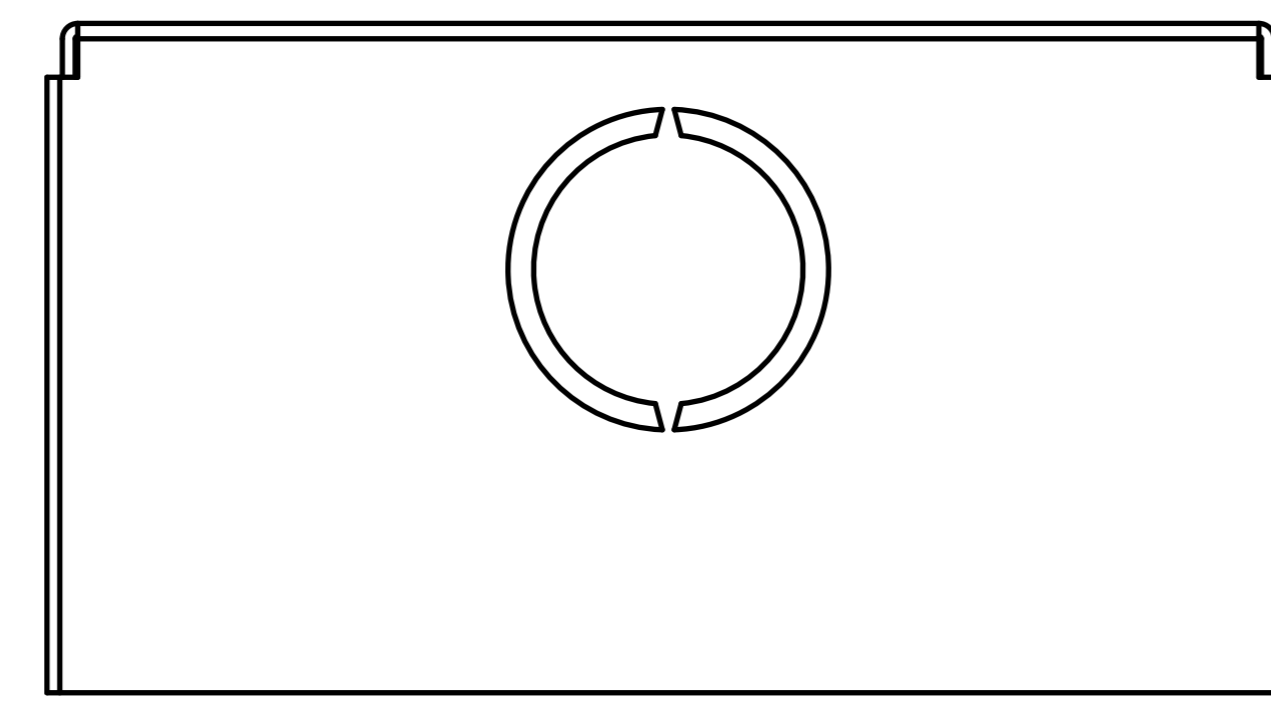

5 TOP VIEW

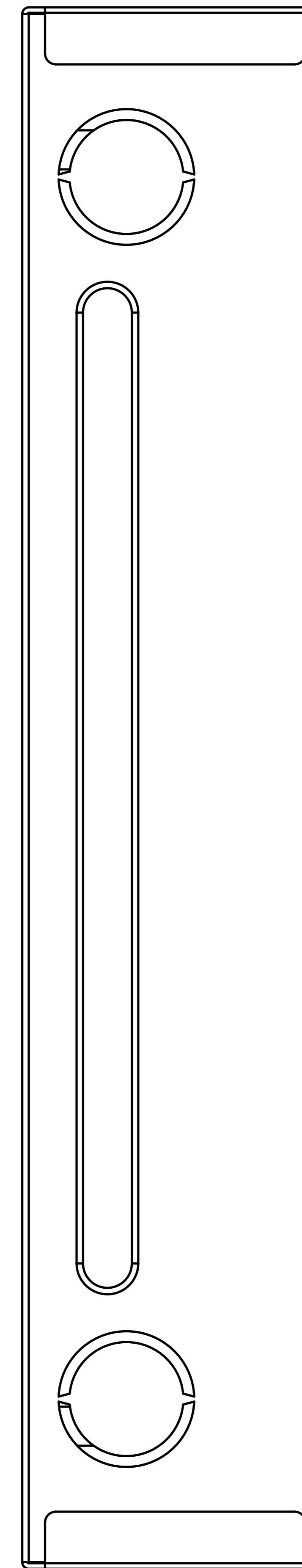

2 RIGHT VIEW

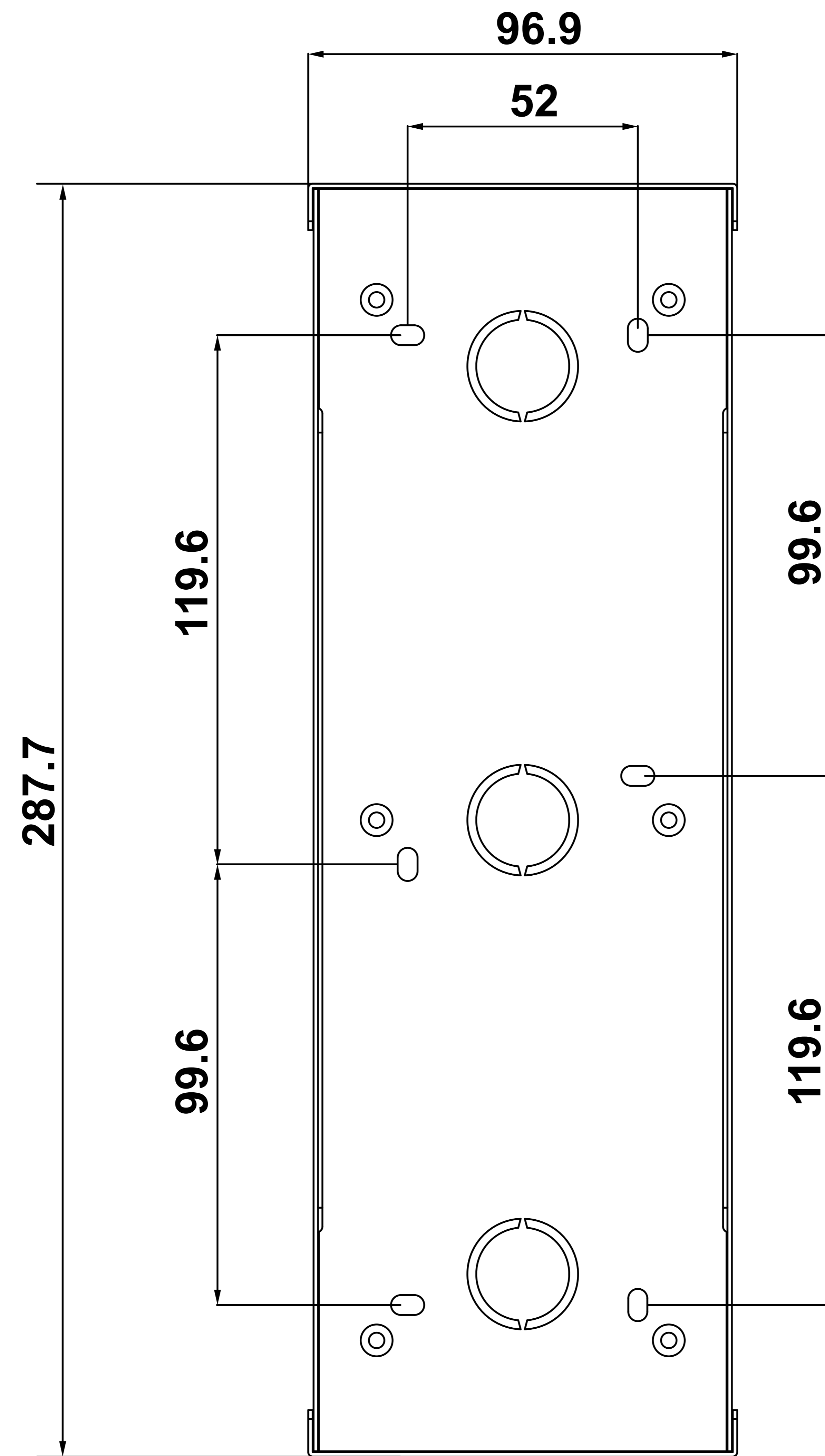

1 FRONT VIEW

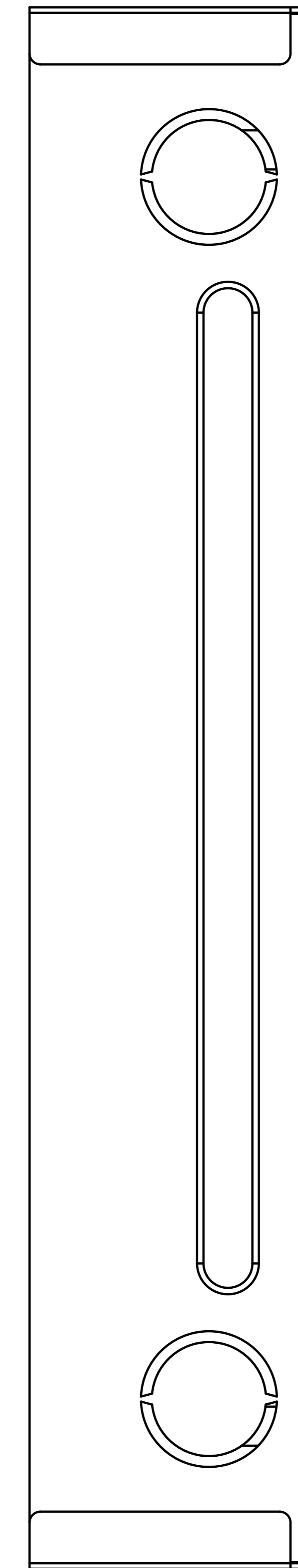

3 LEFT VIEW

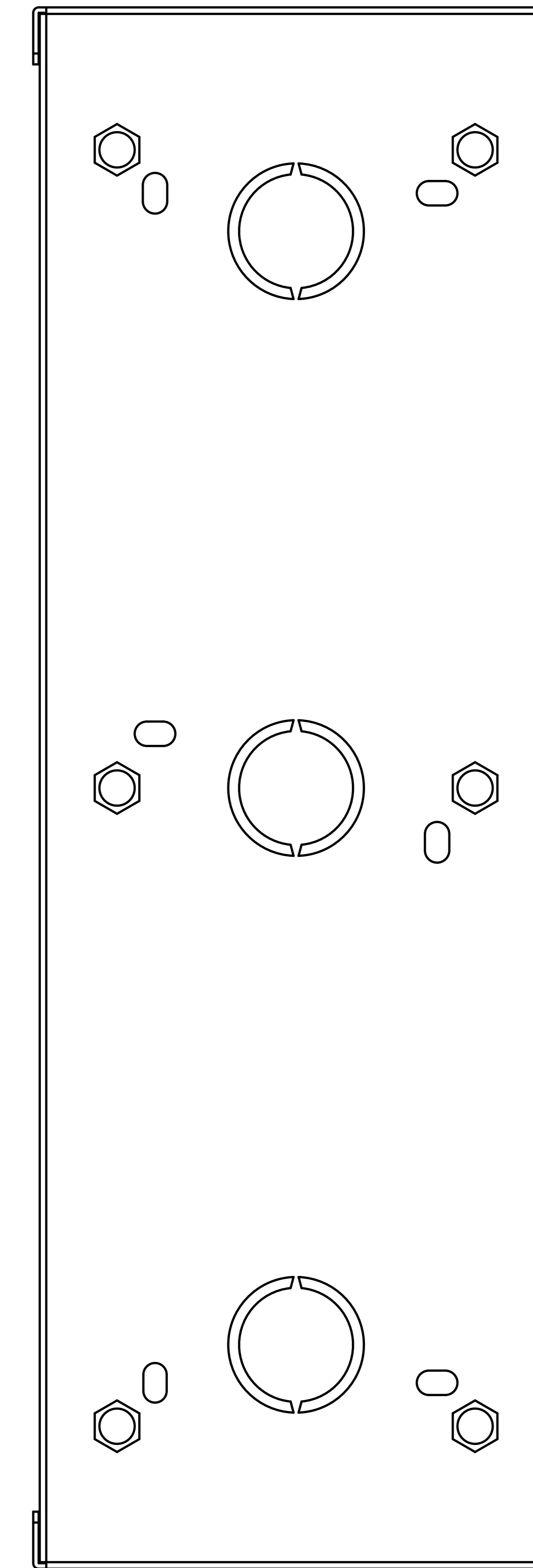

4 BACK VIEW

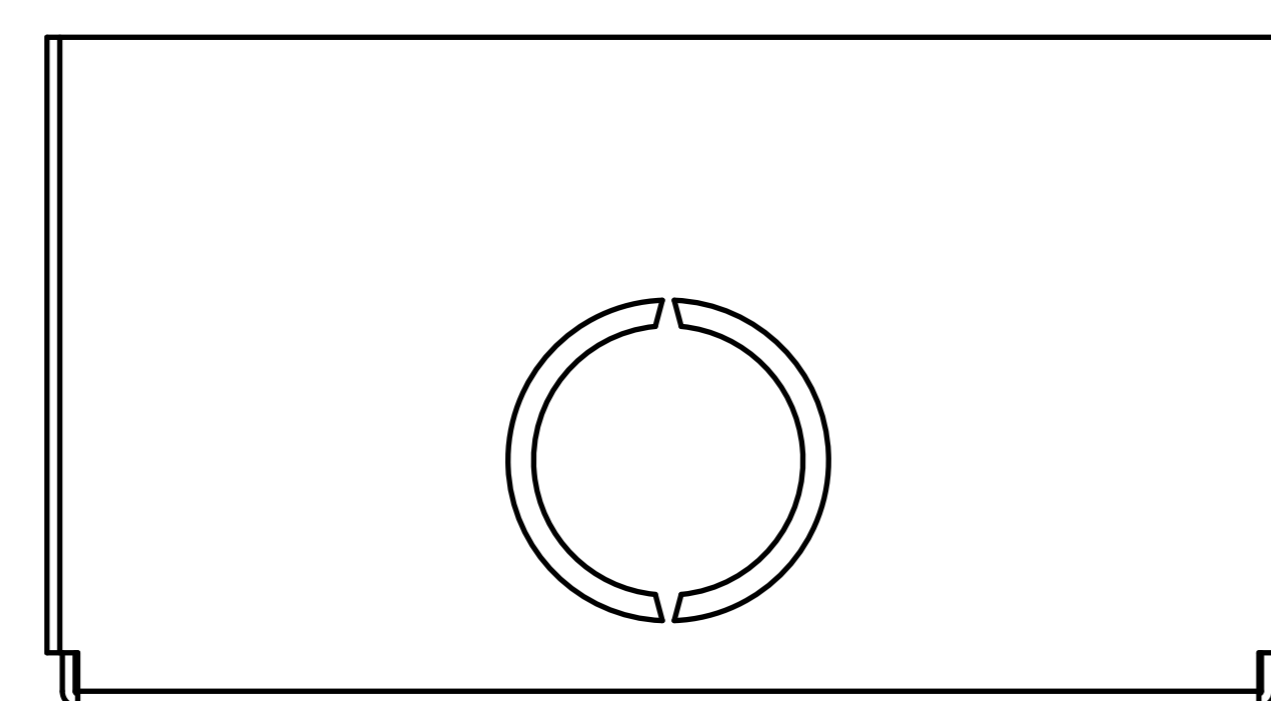

6 BOTTOM VIEW

Applicable Model

S532

Drawing Title

Placement

Drawing Unit

mm

Drawing Scale

Not to scale

**DRAFT
SUBJECT TO
CHANGE**

Last Revised

Dec 15, 2023

Drawing Version

V1.0

Page

6 of 6

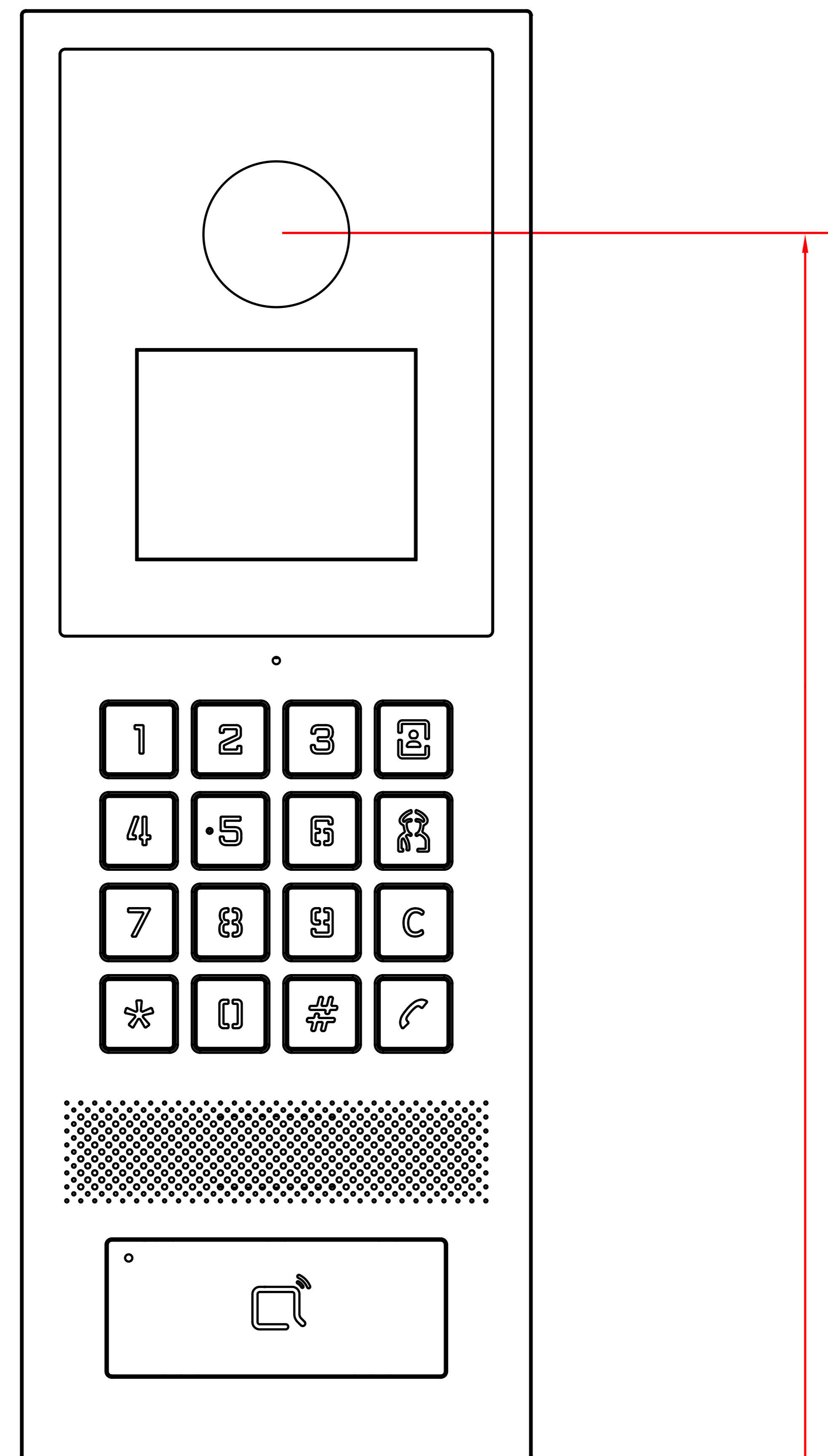

① INTERCOM PANEL FRONT VIEW

1145.5mm TO BOTTOM OF PANEL

1400mm TO CENTER OF CAMERA

ADA Compliance Requirement

GROUND

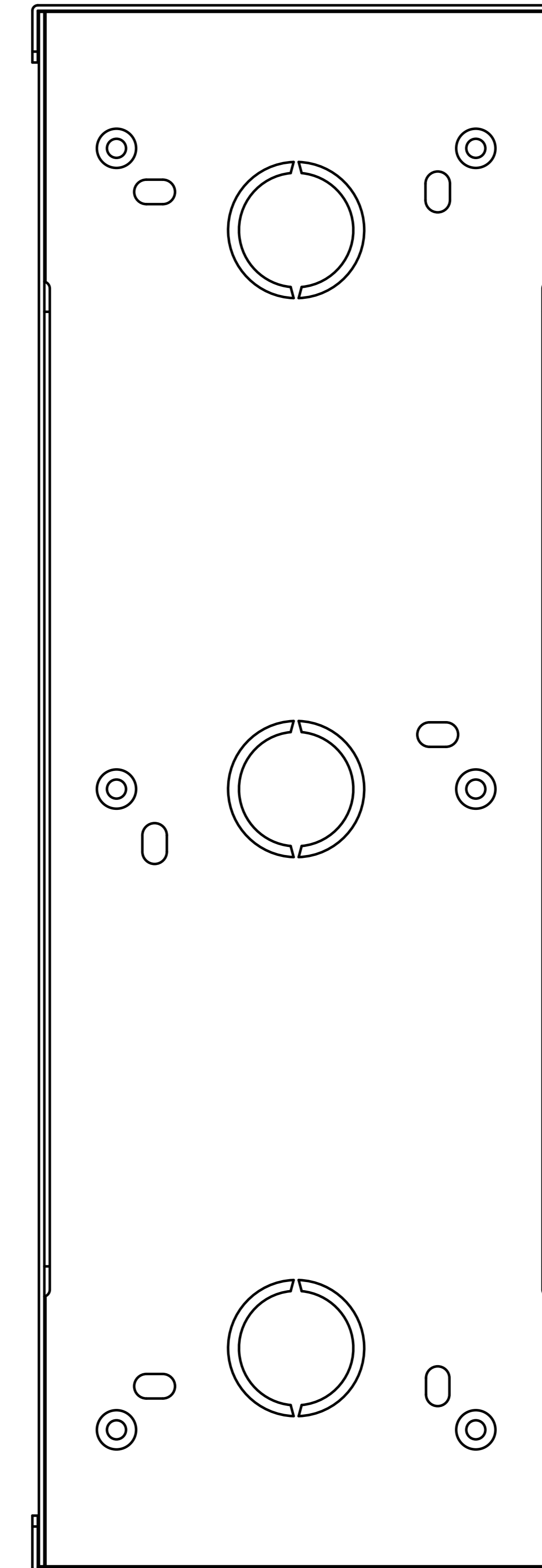

② FRONT VIEW: FLUSHING MOUNTING BOX PLACEMENT

1152mm TO BOTTOM OF BOX

GROUND

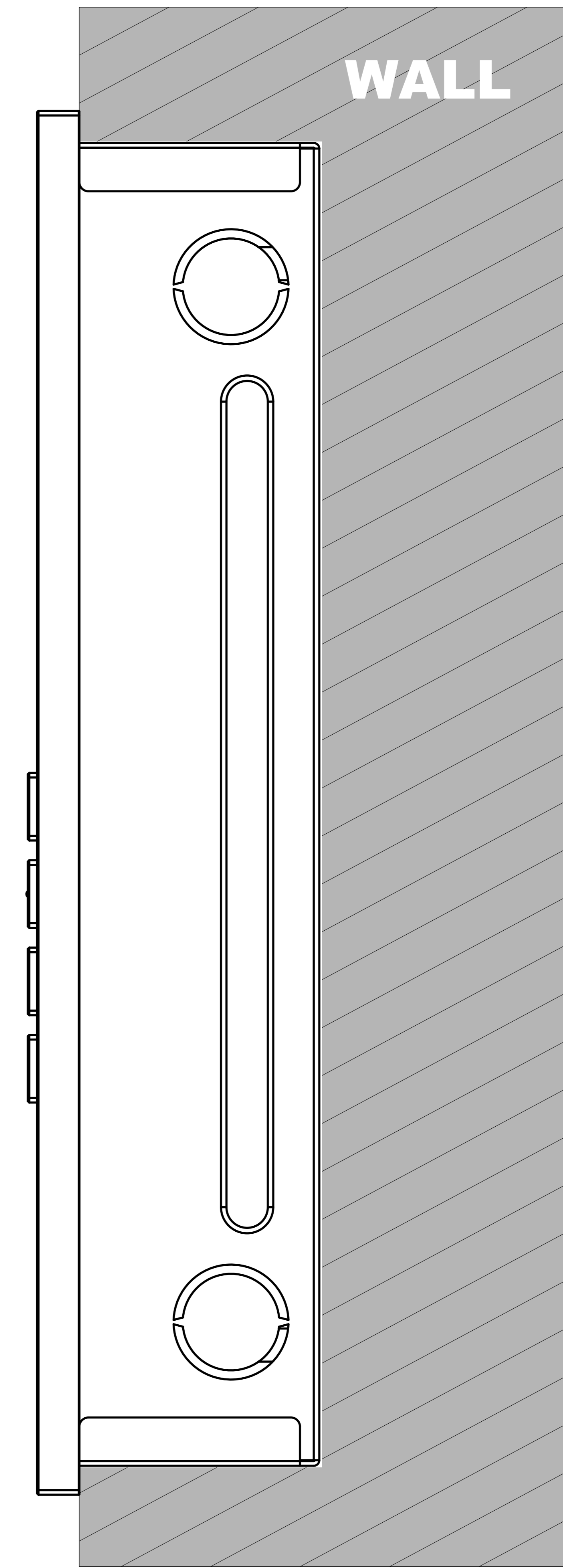

③ SIDE VIEW: INTERCOM IN WALL

WALL